

Varenummer: 2031100M16150B2U

Beskrivelse: E+G Justerfod
GN 31-100-M16-150-B2-U

Note: U Uden møtrik, sekskant i toppen, spændeflade i bunden

Mål

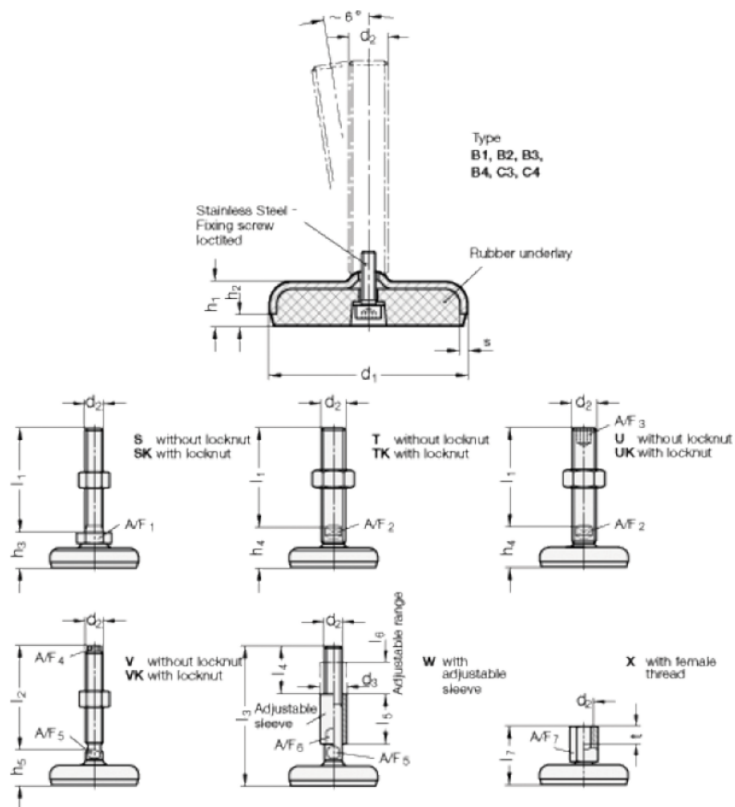

A/F2	= 12	s = 3
A/F3	= 8	
d1	= 100	
d2	= 16	
h1	= 20	
h4 +4.0/0	= 34	
l1	= 150	